

For more reliable connections choose MICROTEST Cable Tester



Continuity Test



O/S Test



Safety Test



Component Test



USB Type-C Test

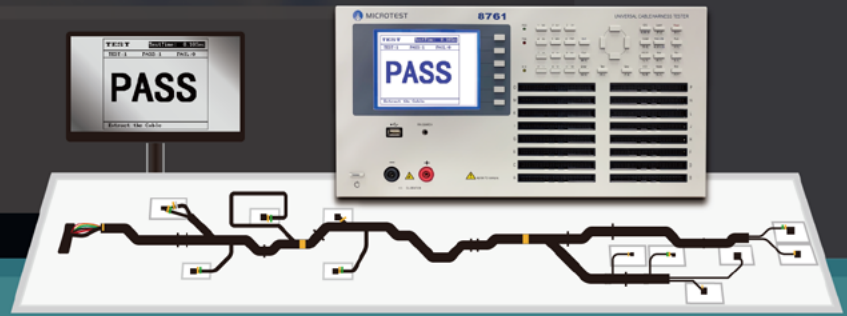

Application



Low-Voltage Electrical Measurement Items



Continuity Test

Verifies whether the cable can conduct current normally by measuring resistance to ensure electrical connectivity within the circuit.

Short/Open Circuit Test

Ensures circuit functionality and safety by detecting potential open or short circuit conditions within the cabling.

Component Test

Validates that the cable assembly can operate within specific electrical environments by measuring integrated components such as resistance, capacitance, and diodes.

High-Voltage Measurement Items

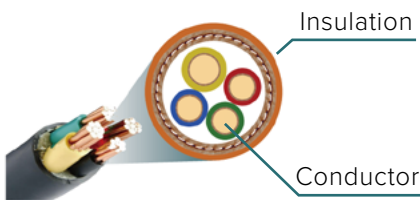

Hipot Test

Verifies insulation integrity by applying high AC/DC voltage and monitoring leakage current between test points.

IR Test

Measures resistance at specific high voltages to ensure insulation reliability under extreme operating conditions.

USB Type-C Testing Items



Orientation Auto-ID

Supports reversible insertion with automatic circuitry learning.

Component Test

Auto-identifies and tests Ra resistors, capacitors, and diodes within the cable.

E-Marker IC

Reads VDO Codes to analyze protocol versions and specifications.

5A Voltage Drop Test

Measures Vbus/ GND voltage differential or internal resistance (DCR).

APPLICATION

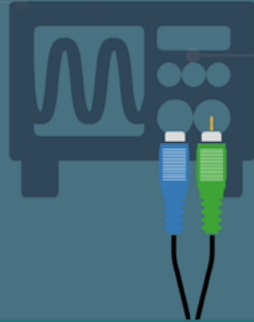

Comprehensive Electrical and Safety Compliance Testing in a Single Unit







One-stop Measurement of Continuity, Short/Open, Hipot, and Insulation Quality



ITEM SEL - File:123		PROG
ITEM	TEST	
[1] OPEN/SHORT	<input checked="" type="checkbox"/>	
[2] CONDUCTANCE	<input checked="" type="checkbox"/>	
[3] COMPONENT	<input type="checkbox"/>	
[4] AC HIPOT	<input type="checkbox"/>	
[5] DC INSUL./HIPOT	<input checked="" type="checkbox"/>	
[6] Q.CONDUCTANCE	<input type="checkbox"/>	
[7] INTERMITTENCE O/S	<input type="checkbox"/>	
[8] Q.INTERMITT. OPEN	<input type="checkbox"/>	

TEST			TestTime: 0.88Sec
TEST:5	PASS:5	FAIL:0	
O/S TEST	PASS	PASS
COND A08*B01	0.087Ω		
COND A07*B02	0.080Ω		
COND A06*B03	0.080Ω		
COND A05*B04	0.084Ω		
COND A04*B05	0.087Ω		
COND A03*B06	0.093Ω		
COND A02*B07	0.085Ω		
COND A01*B08	0.074Ω		
INSUL (MUX) TEST	PASS	
Extract the Cable			

General Wire Harness	Direct Attach Cable, DAC	Automotive Low-Voltage Harness	USB Type-C Cable
			
8740	8761	8761NAK/8740NAK	8761NAC
<ul style="list-style-type: none"> Continuity Test 100mΩ~52Ω AC/DC Hipot Test Insulation Resistance Test 	<ul style="list-style-type: none"> Low Resistance Continuity Test 1mΩ~52Ω AC/DC Hipot Test Insulation Resistance Test 	<ul style="list-style-type: none"> Supports up to 1024 test points AC/DC Hipot Test Insulation Resistance Test 	<ul style="list-style-type: none"> USB-C Orientation Circuit Test Ra Resistor/ Filter Capacitor Test 5A Voltage Drop-Internal Resistance Test
Refer to P.103	Refer to P.95	Refer to P.97/ P.105	Refer to P.109

MICROTEST Provides Customized Solutions: Tailored Test Fixtures for Harness Assemblies



Test Item	Customized Test Fixtures	Device Under Test
<ul style="list-style-type: none"> O/S Continuity Test Insulation Resistance 		<p>8-circuit configuration</p>

Cable Tester

Wiring Methods From Instrument to Device Under Test

Panel to Test Fixture

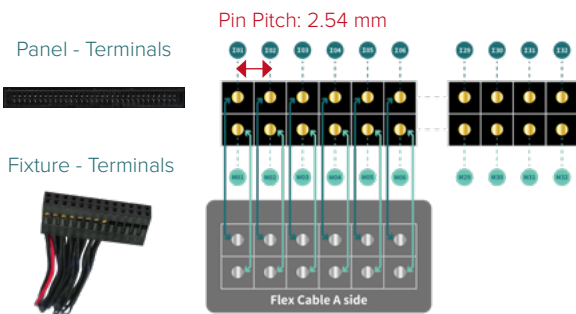

Test Fixture to Harness

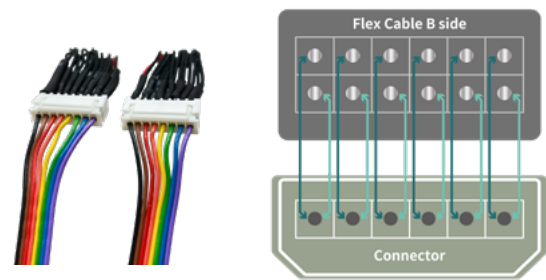

Three High-Voltage/Insulation Measurement Modes to Maximize Throughput

All-Ground

Tests Hipot and insulation between each conductor and the ground (shield) to ensure grounding safety.

Binary

Rapidly determines whether the overall batch is Pass or Fail

Groups conductors in parallel to significantly accelerate Hipot and IR detection efficiency.

All Nets

Displays individual Hipot and insulation values for each conductor core

Progressively tests each conductor against all remaining conductors to evaluate insulation performance.

Optimization Based on Production Capacity

On the production line, Binary and All Nets Modes can be enabled simultaneously

- If the result is PASS: The test cycle completes immediately, ensuring maximum efficiency.
- If the result is FAIL: The instrument automatically triggers a sequential, conductor-by-conductor scan to pinpoint the specific defective core.

Mode	Step	1	2	3	4	5	6	7	8
Binary Mode	STEP 1	+	+	+	+	-	-	-	-
	STEP 2	+	+	-	+	+	-	-	-
	STEP 3	+	-	+	-	+	+	-	-
All Nets Mode	STEP 1	+	-	-	-	-	-	-	-
	STEP 2	-	+	-	-	-	-	-	-
	STEP 3	-	-	+	-	-	-	-	-
	STEP 4	-	-	-	+	-	-	-	-
	STEP 5	-	-	-	-	+	-	-	-
	STEP 6	-	-	-	-	-	+	-	-
	STEP 7	-	-	-	-	-	-	+	-
	STEP 8	-	-	-	-	-	-	-	+

HIPOUT File:123

Item	DC	Hipot
111 Voltage	50V	200V
121 Frequency	Insul.	50Hz
131 Test rate	NOFR	NOFR
141 Spec.	0.1MP	0.50MA
151 HFFsel	0.0MP	0.00MA
161 All-Ground	OFF	OFF
171 Binary	ON	ON
181 Time	0.01Sec	0.01Sec
191 All nets	OFF	OFF
1101Time	0.01Sec	0.01Sec
111CMD pin	001	001

AC ZERU
DC ZERN
CLR ZERU
NEXT PAGE

TEST I TestTime: 0.77Sec

TEST:4 PASS:4 FAIL:0

O/S TEST PASS
INSUL (MUX) TEST PASS

Extract the Cable

HIPOUT File:123

Item	DC	Hipot
111 Voltage	50V	200V
121 Frequency	Insul.	50Hz
131 Test rate	NOFR	NOFR
141 Spec.	0.1MP	0.50MA
151 HFFsel	0.0MP	0.00MA
161 All-Ground	OFF	OFF
171 Binary	OFF	OFF
181 Time	0.01Sec	0.01Sec
191 All nets	OFF	OFF
1101Time	0.01Sec	0.01Sec
111CMD pin	001	001

AC ZERU
DC ZERN
CLR ZERU
NEXT PAGE

TEST I TestTime: 1.09Sec

TEST:3 PASS:3 FAIL:0

O/S TEST PASS
INSUL (A03) 1200.00MP
INSUL (A07) 1200.00MP
INSUL (A05) 1200.00MP
INSUL (A04) 1200.00MP
INSUL (A03) 1200.00MP
INSUL (A02) 1200.00MP

Extract the Cable

4-Wire Cable Harness Tester

8761

Test Pin

4-Wire (64/128/256)

Cable Tester



MICROTEST 8761 series Cable Harness Tester employs precise 4-wire measurement technology to perform comprehensive electrical characteristic tests on wire harness products, meeting the low resistance level of $1m\Omega$. The testing capabilities include continuity impedance, open/short circuit, AC/DC safety withstand voltage, IR insulation, and component testing (resistor/capacitor/diode). The testing points can be selected from 64/128/256 options, with a maximum AC withstand voltage output of 1000V and a maximum DC withstand voltage output of 1500V. It supports PC Link software and BAR Code scanning, meeting the requirements for automated line testing in wire and connector production.

Application

Consumer electronics wire harnesses, Automotive hook up wires, Automotive grade wire harnesses, Connectors, Flexible flat cables

Feature

- 4-wire measurement Continuity Test $1m\Omega$ - 52Ω
- Test pin 64/ 128/ 256
- Number of test file up to 500 sets
- Multiple DUT test-4 (standard)/ expand 14 (option)
- USB Host stores setting files and can update firmware
- Support bar code scan and print function

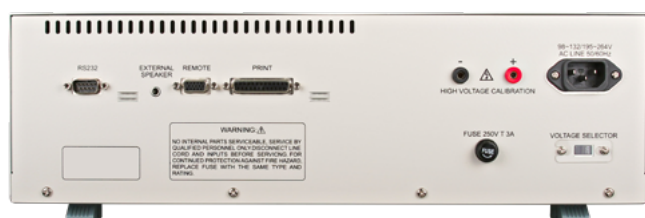

Standard Interfaces

RS-232

USB Host

Remote

Print

Specification

Model	8761FA	8761NA	8761N
Measuring Mode	4-wire		
Test Pin	64/128/256		
Safety Hipot Test			
AC Hipot Test	100~1000V	100~700V	-
DC Hipot Test	50~1500V	50~1000V	50~1000V
AC Hipot Leakage Current	0.01mA~5mA		
AC Arcing Detection	1~48		
DC Hipot Leakage Current	0.1uA~1200uA		
DC Arcing Detection	1~48		
DC Hipot Insulation Resistance	1MΩ~1.2GΩ		
Hipot Output Accuracy	±5%		
Hipot Measurement Accuracy	±5%		
Rated Output	5Vdc		
Hipot Measurement Time	0.01sec~60sec		
Wire Specifications	Maximum allowable capacitance 5μF		
Low Voltage Electrical Test			
Continuity Test	Measurement Range	1mΩ~52Ω	
	Current Signal	10mA	
Intermittence Continuity Test	100mΩ~52Ω		
O/S, Intermittence O/S, Quick Intermittence Open Circuit	1kΩ~100kΩ		
O/S Terminal Judge	●		
Single-Side Test	●		
Component Test			
Resistance	Measurement Range	50mΩ~20MΩ	
	Level Signal	0.1~3V	
Capacitance	Measurement Range	10pF~12μF	
	Frequency Signal	AUTO Gear (Optional) 48Hz/ 480Hz/ 4.8kHz/ 48kHz	
	Level Signal	0.1V~1.2V	
Diode	Measurement Range	0.1~6.8V	
Advanced Functions	Programmable continuous test/ Auto Pin search/ Auto-diagnosis		
Test Scan Mode	Auto, Manual, External Trigger		
Measurement Signal	Low Voltage Measurement Signal		
Built-in Storage	Number of test file up to 500 sets		
Panel	System/ Rapid/ Edit/ Function		
Indicator	Pass/ Fail HV LED red-green indicator lights/ Screen Display/ Sound		

General

Power Supply	Fixed Voltage : 115/230 Vac ±10%, Frequency : 60/50Hz
Power Consumption	64PIN : 70VA, 128PIN : 70VA, 256PIN : 100VA
Interface	RS-232, USB Host, Print, Remote
PC Link Software	●
Operation	Manual, Auto, Remote Control
Display	320*240 dot-matrix
Environment	Temperature : 15°C-35°C, Humidity : RH≤70%
Dimension (W*H*D)	64 PIN : 435x145x406mm, 128 PIN : 435x145x406mm, 256 PIN : 435x190x406mm
Weight	64 PIN : 8.44kg, 128 PIN : 9.3kg, 256 PIN : 14kg

4-Wire Cable Harness Tester

8761NAK

Test Pin
4-Wire(512)

Cable Tester



MICROTEST 8761K series Cable Harness Tester employs precise 4-wire measurement technology to perform comprehensive electrical characteristic tests on wire harness products with low resistance levels of $1\text{m}\Omega$. The testing capabilities include Continuity Test, open/short circuit, AC/DC safety withstand voltage, IR insulation, and component testing (resistor/capacitor/diode). The testing points are selectable up to 512 points, with a maximum AC withstand voltage output of 700V and a maximum DC withstand voltage output of 1000V. It supports PC Link software and BAR Code scanning, meeting the requirements for automated line testing in wire and connector production.

Application

Consumer electronics wire harnesses, Automotive hook-up wires, Automotive-grade wire harnesses, Connectors, Flexible flat cables

Feature

- 4-wire measurement Continuity Test $1\text{m}\Omega\sim 52\Omega$
- Low Resistance Scanning Test $10\text{m}\Omega\sim 52\Omega$
- AC Hipot Test 700V max.
- DC Hipot Test 1000V max.
- Test pin 512
- Insulation Resistance Test
- Continuity, O/S, Intermittence O/S Test
- Support bar code scan and print function
- Support multi product testing



Standard Interfaces

RS-232

USB Host

Remote

Print

Specification

Model	8761NAK		8761NK	
Measuring Mode	4-wire			
Test Pin	512			
Safety Hipot Test				
AC Hipot Test	100~700V		-	
DC Hipot Test	50~1000V		50~1000V	
AC Hipot Leakage Current	0.01mA~5mA			
AC Arcing Detection	1~48			
DC Hipot Leakage Current	0.1uA~1200uA			
DC Arcing Detection	1~48			
DC Hipot Insulation Resistance	1MΩ~1.2GΩ			
Hipot Output Accuracy	±5%			
Hipot Measurement Accuracy	±5%			
Rated Output	5Vdc			
Hipot Measurement Time	0.01sec~60sec			
Wire Specifications	Maximum allowable capacitance 5μF			
Low Voltage Electrical Test				
Continuity Test	Measurement Range	1mΩ~52Ω		
	Current Signal	10mA		
Intermittence Continuity Test	100mΩ~52Ω			
O/S, Intermittence O/S, Quick Intermittence Open Circuit	1kΩ~100kΩ			
Low resistance Scanning	Measurement Range	10mΩ~52Ω		
	Current Signal	10mA		
O/S Terminal Judge	●			
Single-Side Test	●			
Component test				
Resistance	Measurement Range	50mΩ~20MΩ		
	Level Signal	0.1~3V		
Capacitance	Measurement Range	10pF~12μF		
	Frequency Signal	AUTO Gear (Optional) 48Hz/ 480Hz/ 4.8kHz/ 48kHz		
	Level Signal	0.1V~1.2V		
Diode	Measurement Range	0.1~6.8V		
Advanced Functions	Programmable continuous test/ Auto Pin search/ Auto-diagnosis			
Test Scan Mode	Auto, Manual, External Trigger			
Measurement Signal	Low Voltage Measurement Signal			
Built-in Storage	Number of test file up to 500 sets			
Panel	System/ Rapid/ Edit/ Function			
Indicator	Pass/ Fail HV LED red-green indicator lights/ Screen Display/ Sound			

General

Power Supply	Fixed Voltage : 115/230 Vac ±10%, Frequency : 60/50Hz
Power Consumption	250VA
Interface	RS-232, USB Host, Print, Remote
PC Link Software	●
Operation	Manual, Auto, Remote Control
Display	320*240 dot-matrix
Environment	Temperature : 15°C~35°C, Humidity : RH≤70%
Dimension (W*H*D)	435x270x360 mm
Weight	18kg

Functions

4-Wire measurement, achieving precise measurement of conductor impedance down to 1mΩ.

The 8761/8761NAK series utilizes a 4-Wire measurement technique, directly connected to both ends of the test harness for measurement, avoiding errors introduced by overall wiring, achieving precise measurement of conductor impedance down to 1mΩ.

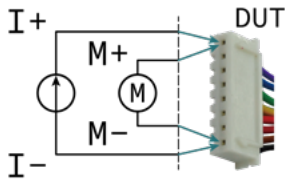

Example: Test Pin 128

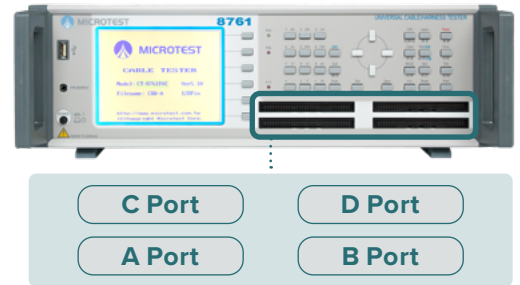

A Port (1~32PIN)

B Port (1~32PIN)

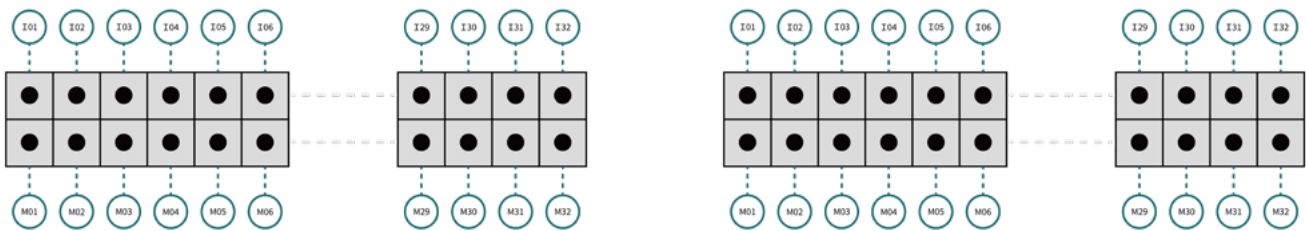

All-in-One Cable Electrical Quality Testing

8761/ 8761NAK series precisely measures insulation, continuity, and resistance performance to ensure each cable assembly meets standards and maintains strict quality control.

Support for Open/Short Circuit Testing

When the open/short circuit test function is enabled, the instrument automatically learns the loop of the harness. It detects points at both ends of the cable circuit or between DUTs that should not be connected together, identifying faults caused by unintended short circuits.

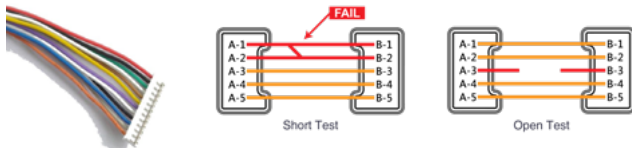

Model	Open/Short Test
8761	1kΩ~100kΩ
8761NAK	1kΩ~100kΩ

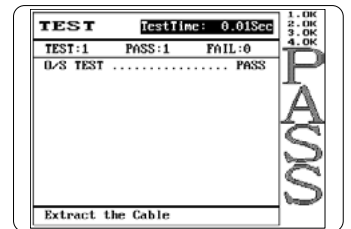
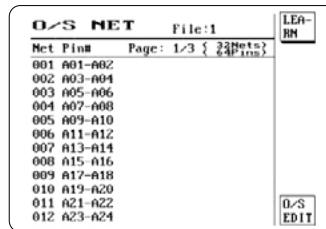

Support for Continuity Testing

With the continuity test function enabled, the instrument checks all connected pins of the cable for proper continuity, judging by the resistance values.

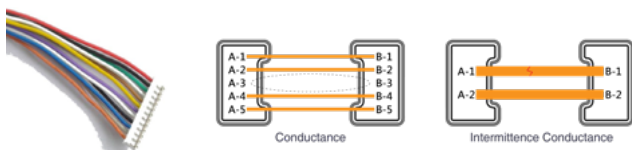

Model	Continuity Test	Intermittence Continuity Test
8761	1mΩ~52Ω	100mΩ~52Ω
8761NAK	1mΩ~52Ω	100mΩ~52Ω

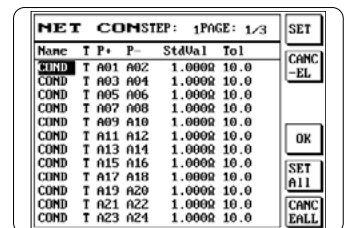
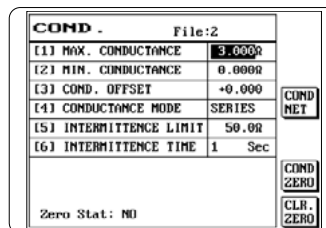

Support for AC/DC Hipot and insulation testing

MICROTEST Cable Tester supports AC/DC Hipot and insulation testing. It applies a stable high voltage to test the dielectric strength and insulation performance of cables. The tester can also enable arc detection to assess whether cable connectors arc under high voltage conditions, ensuring compliance with safety standards for cable quality.

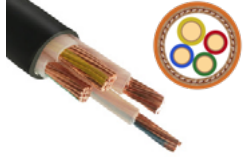

HIPOT		File: BURN-1	
Item	DC	Hipot	
[1] Voltage	1000V	700V	
[2] Frequency	Insu.	60Hz	
[3] Time	0.10Sec	0.10Sec	
[4] Spec.	1000.0MA	0.50mA	
[5] Offset		0.00mA	
[6] All-Ground	OFF	OFF	
[7] Binary	ON	ON	
[8] All nets	OFF	OFF	
[9] GND pin	A01	A01	
[10] Test rate	FAST	SUPER	
[11] Max. pin	12B	12B	

Model	8761NAK	8761NK	8761FA	8761NA	8761N
AC Voltage/ Leakage Current	100V~700V/ 5mA	-	100V~1000V/ 5mA	100V~700V/ 5mA	-
DC Voltage/ Leakage Current	50V~1000V/ 1200μA	50V~1000V/ 1200μA	50V~1500V/ 1200μA	50V~1000V/ 1200μA	50V~1000V/ 1200μA
Insulation Voltage/Range	50V~1000V/ 1.2GΩ	50V~1000V/ 1.2GΩ	50V~1500V/ 1.2GΩ	50V~1000V/ 1.2GΩ	50V~1000V/ 1.2GΩ

Supports Capacitor, Resistor, and Diode Tests

Many wiring harnesses incorporate protection mechanisms by adding protective components. For example, USB Type-C fast-charge cables often install transient voltage suppressor (TVS) diodes between the plug/socket pins and ground to guard against transient or reverse voltages. In industrial control systems, harnesses frequently face electromagnetic interference and overvoltage risks, so protection devices are used to strengthen their immunity to interference.

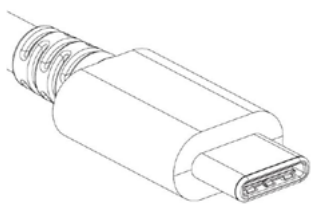

EDIT		STEP: 1PAGE: 1/1		MEAS STEP	
Name	T	P+	P-	StdVal	Tol%
1	R	A01	B01	1.000k	10.0
2	C	A01	B01	1.000n	10.0
3	D	A01	B01	0.700V	10.0
4	V	A01	B01	1.000V	10.0
5	T	A01	B01	1.000R	10.0

EDIT		STEP: 1PAGE: 1/1		MEAS STEP	
Name	T	P+	P-	StdVal	Tol%
1	D	A01	B01	0.700V	10.0

SET PARAMETER
 DIODE TEST MOD: CURRENT
 SET DIODE CURR: 1.0 mA

MICROTEST Cable Tester supports capacitance, resistance, and diode testing.

Model	Capacitance Test	Resistance Test	Diode Test
8761	10pF~12μF	50mΩ~20MΩ	0.1~6.8V
8761NAK	10pF~12μF	50mΩ~20MΩ	0.1~6.8V

PC Link & Barcode printing

Supports computer connectivity software and barcode testing equipment, meeting comprehensive product traceability and data storage needs on production lines.

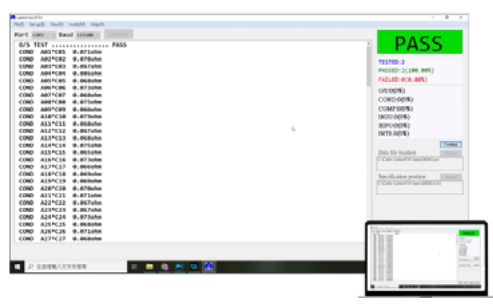

Automatic Chassis Dimension

- Dimension (mm)
- 64 PIN

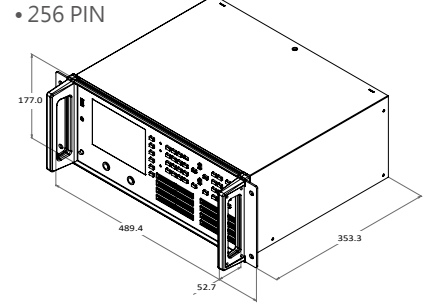
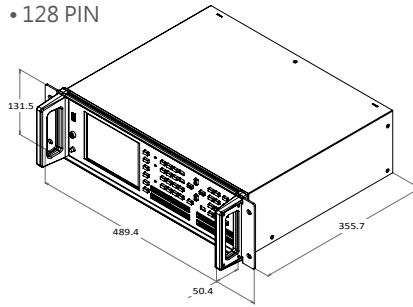
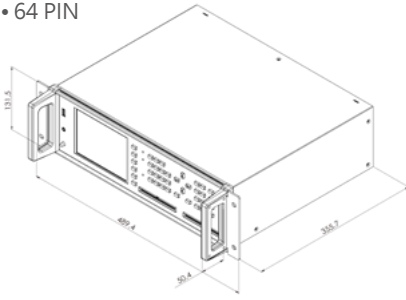

Appearance

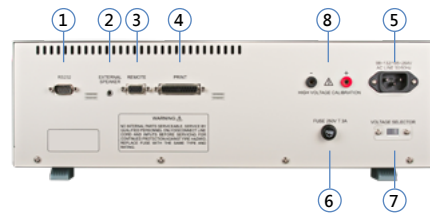
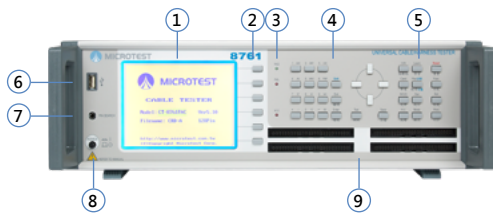

- | | | | |
|--|--|---|---|
| <ol style="list-style-type: none"> 1. LCD Screen 2. Function Key 3. PASS & FAIL & HIPOT 4. Direction & Number Key 5. System Key | <ol style="list-style-type: none"> 6. USB 7. Pin Search 8. Power Switch 9. 64Pin: 2 Slots, 128Pin: 4 Slots | <ol style="list-style-type: none"> 1. RS232 2. Audio Output Socket 3. Remote 4. Printer | <ol style="list-style-type: none"> 5. AC INPUT 6. Fuse Block 7. 115/230V Switch 8. High Voltage Correction Output Connector |
|--|--|---|---|

Ordering Information

4-Wire Cable Tester	Standard	Optional
<p>8761 Series</p> <ul style="list-style-type: none"> • 8761FA (64Pin/AC 1000V/DC 1500V) • 8761NA (64Pin/AC 700V/DC 1000V) • 8761N (64Pin/DC 1000V) • 8761FA (128Pin/AC 1000V/DC 1500V) • 8761NA (128Pin/AC 700V/DC 1000V) • 8761N (128Pin/DC 1000V) • 8761FA (256Pin/AC 1000V/DC 1500V) • 8761NA (256Pin/AC 700V/DC 1000V) • 8761N (256Pin/DC 1000V) 	<p>8761 Series</p> <ul style="list-style-type: none"> • FX-000C16 Adapter Board • AK-8600F2 Cable-64pin TO 64pin (40cm) • TL-CB0006 Search Pin-Probe (150cm) • Power Cord 	<ul style="list-style-type: none"> • FX-CB0001 Wi-Fi Fixture • F874001 Multiple DUT Testing Expand Box (Expand up to 14 DUTs) • F874002 Multiple DUT Testing Expand Box (Expand up to 14 DUTs/ Signal Light Display) • F874004 Networking Fixture • F874005 Remote Signal Light Box • FX-000C15 Adapter Board (4-wire 64pin TO 2-wire 64pin) • FX-000C17 Adapter Board (4-wire 32pin TO 2-wire 32pin) • FX-000C25 Remote Expansion Box (Multiple DUT Test/ Remote Signal Light Display) • FX-000C27 Current Expand Box- 5A Voltage Drop Test • FX-000C18 Intermience O/S Fixture • AK-8600F1 Cable-64pin TO 64pin (30cm) • AK-8600F2 Cable-64pin TO 64pin (40cm) • TL-CB0001 Cable-64pin TO 64pin (100cm) • TL-CB0002 Cable-64pin TO 64pin (200cm) • TL-CB0005 Cable-64pin TO 64pin (40cm) • FB-8600M1 Universal Fixture Board • F760001 D-Sub Foot Switch (15 PIN) • TL-000011 USB TO RS-232 Cable • TL-000003 RS-232 Cable (180cm) • KB-8750K1 Calibration Kits-4-Wire Model.8761/ 8761 • TM-U220PB-T EPSON Printer-TM-U220PB (Traditional Chinese/English) • TM-U220PB-S EPSON Printer-TM-U220PB (Simplified Chinese/English) • PC Link Software

Automatic Chassis Dimension

• Dimension (mm)

• 512 PIN

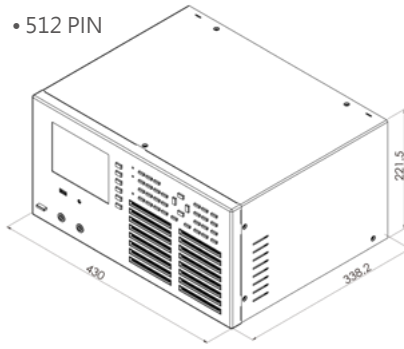

Appearance



- 1. LCD Screen
- 2. Function Key
- 3. PASS & FAIL & HIPOT
- 4. Direction & Number Key
- 5. System Key
- 6. USB
- 7. Pin Search
- 8. Power Switch
- 9. High Voltage Correction Output Connector
- 10. 512Pin: 16 Slots

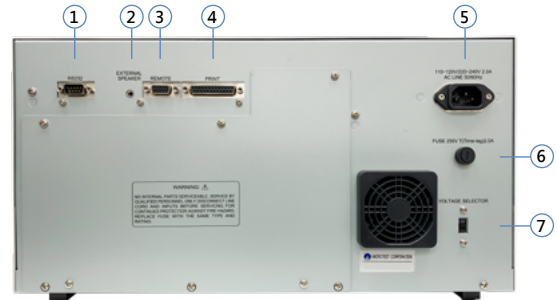

- 1. RS232
- 2. Audio Output Socket
- 3. Remote
- 4. Printer
- 5. AC INPUT
- 6. Fuse Block
- 7. 115/230V Switch

Ordering Information

4-Wire Cable Tester	Standard	Optional
<p>8761NAK Series</p> <ul style="list-style-type: none"> 8761NAK (512Pin/AC 700V/DC 1000V) 8761NK (512Pin/DC 1000V) 	<p>8761NAK Series</p> <ul style="list-style-type: none"> FX-000C16 Adapter Board TL-CB0005 Cable-64pin TO 64pin (40cm) TL-CB0006 Search Pin-Probe (150cm) Power Cord 	<ul style="list-style-type: none"> FX-CB0001 Wi-Fi Fixture F874001 Multiple DUT Testing Expand Box (Expand up to 14 DUTs) F874002 Multiple DUT Testing Expand Box (Expand up to 14 DUTs/Signal Light Display) F874004 Networking Fixture F874005 Remote Signal Light Box FX-000C15 Adapter Board (4-wire 64pin TO 2-wire 64pin) FX-000C17 Adapter Board (4-wire 32pin TO 2-wire 32pin) FX-000C25 Remote Expansion box (Multiple DUT Test/ Remote Signal Light Display) FX-000C27 Current Expand Box- 5A Voltage Drop Test FX-000C18 Intermience O/S Fixture AK-8600F1 Cable-64pin TO 64pin (30cm) AK-8600F2 Cable-64pin TO 64pin (40cm) TL-CB0001 Cable-64pin TO 64pin (100cm) TL-CB0002 Cable-64pin TO 64pin (200cm) TL-CB0005 Cable-64pin TO 64pin (40cm) FB-8600M1 Universal Fixture Board F760001 D-Sub Foot Switch (15 PIN) TL-000011 USB TO RS-232 Cable TL-000003 RS-232 Cable (180cm) KB-8750K1 Calibration Kits-4-Wire Model.8761/ 8761 TM-U220PB-T EPSON Printer-TM-U220PB (Traditional Chinese/English) TM-U220PB-S EPSON Printer-TM-U220PB (Simplified Chinese/English) PC Link Software

Fixture & Accessories

TL-CB0006
Probe



TL-CB0003
Probe



AK-8600F2
Cable



Applicable Models	8740/ 8761/ 8761NAC/ 8761NAK/ 8740NAK	8730	8740/ 8761/ 8761NAC
Accessory Description	150cm	105cm	40cm 64pin TO 64pin

TL-CB0005
Cable



AK-8600F1
Flexible Flat Cable

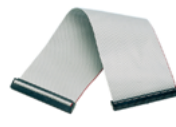

TL-CB0001
Cable

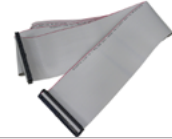

Applicable Models	8761NAK/ 8740NAK	8740/ 8761/ 8761NAC/ 8740NAK	8740/ 8761/ 8761NAC/ 8740NAK
Accessory Description	40cm 64pin TO 64pin	30cm 64pin TO 64pin	100cm 64pin TO 64pin

TL-CB0002
Cable

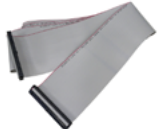

FX-000C15
Adapter Board



FX-000C16
Adapter Board

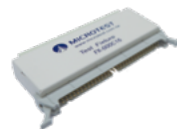

Applicable Models	8740/ 8761/ 8761NAC/ 8761NAK/ 8740NAK	8761/ 8761NAC/ 8761NAK	8740/ 8761/ 8761NAC/ 8761NAK/ 8740NAK
Accessory Description	200cm 64pin TO 64pin	4-wire 128pin TO 2-wire 64pin	2-wire 64pin TO 2-wire 64pin

FX-000C17
Adapter Board



FX-000C21
USB Type-A Test Fixture



FX-000C22
USB Type-C Test Fixture



Applicable Models	8761/ 8761NAC/ 8761NAK	8761NAC	8761NAC
Accessory Description	4-wire 64pin TO 2-wire 32pin	USB Type-A test fixture	USB Type-C test fixture

8740-F2
USB Type-C Test Fixture



TL-CB0004
Cable-26pin to 26pin



FX-000C27
Current Expand Box



Applicable Models	8761NAC	8761NAC	8740/ 8761/ 8761NAC/ 8761NAK/ 8740NAK
Accessory Description	USB Type-C test fixture	Supports USB Type-C Test Fixture 8740-F2 40cm	5A Voltage Drop Test Applicable to Wire Harness

FX-000C18
Intermience O/S Fixture



FX-000C25
Remote Expand Box



Applicable Models	8740/ 8761/ 8761NAC/ 8761NAK/ 8740NAK	8740/ 8761/ 8761NAC/ 8761NAK/ 8740NAK
Accessory Description	Electronic Short/ Open Circuit Simulator (µs-ms range), with BNC output for oscilloscope connection; electronic switch withstand voltage up to 5V	Multiple DUT Test, Remote Signal Light Display

F874001
Multiple DUT Testing Expand Box



F874002
Multiple DUT Testing Expand Box



F874005
Remote Signal Light Box



Applicable Models	8740/ 8761/ 8761NAC/ 8761NAK/ 8740NAK	8740/ 8761/ 8761NAC/ 8761NAK/ 8740NAK	8740/ 8761/ 8761NAC/ 8761NAK/ 8740NAK
Accessory Description	Expand up to 14 DUTs	Expand up to 14 DUTs/ Signal Light Display	Remote Signal Light Display

FB-8600M1
Universal Fixture Board



F760001
D-Sub Foot Switch (15 PIN)



TL-000012
D-Sub Cable



Applicable models	8740/ 8761/ 8761NAC/ 8761NAK/ 8740NAK	8740/ 8761/ 8761NAC/ 8761NAK/ 8740NAK	8740/ 8761NAC/ 8740NAK
Accessory Description	Terminal test	Using in production line	150cm 15M TO 15M

TL-000011
USB to RS-232 Cable



TL-000003
RS-232 Cable (180cm)



KB-8750K1
Calibration Kits-4 Wire



Applicable Models	8740/ 8761/ 8761NAC/ 8761NAK/ 8740NAK	8740/ 8761/ 8761NAC/ 8761NAK/ 8740NAK	8761
Accessory Description	Using in production line	Using in production line	9 pcs

KB-8730K1
Calibration Kits-2 Wire



TM-U220PB-T
EPSON Printer (Traditional Chinese/ English)



TM-U220PB-S
EPSON Printer (Simplified Chinese/ English)



Applicable Models	8730/8740	8730/ 8740/ 8761/ 8761NAC/ 8740NAK	8730/ 8740/ 8761/ 8761NAC/ 8740NAK
Accessory Description	6 pcs	Connect print port, for print testing data	Connect print port, for print testing data

F874004
Networking Fixture



8730-J2
Adapter Board



Applicable Models	8740/ 8761/ 8761NAC/ 8761NAK/ 8740NAK	8740
Accessory Description	Turn RS232 connector to ethernet 10/ 100 Mbps	64pin

FX-CB0001
Wi-Fi Fixture

FX-000C28C
2-in-1 Current Expand Box

Applicable Models	8740/ 8761/ 8761NAC/ 8761NAK/ 8740NAK	8761NAC
Accessory Description	Wi-Fi Fixture	5A Voltage Drop Test, E-Marker IC test Top pin header for external test leads